



深圳市晶科鑫实业有限公司

样品承认书

客户代码:	
物料名称:	贴片晶振
规格型号:	SMD5032/4PIN 27.120MHZ 20PF ±10PPM -40~85°C
P N/ SJK:	7I27120E20UCG
环保属性:	<input checked="" type="checkbox"/> RoHS <input checked="" type="checkbox"/> REACH <input checked="" type="checkbox"/> HF <input type="checkbox"/> PAHS <input type="checkbox"/> 其它
版 次:	A1 2017-5-10 初版
湿敏等级:	一级

承 认 签 章					
供 应 商 承 认			() 公 司 承 认		
制定	审核	核准	工 程 师	审 核	批 准
贺丹斌		黄灏东			
SJK 支持	18682088994 (Mr.黄)		盖章签署		
FAE_EMAIL	sjk-fae@q-crystal.com		日 期		
日 期			批示: <input type="checkbox"/> 接受 <input type="checkbox"/> 有条件接受		
备注:					

QUARTZ CRYSTAL UNIT



SERIES 71, SEAM SEALED CERAMIC 5.0*3.2MM SURFACE MOUNT PACKAGE

1. FEATURE/产品特征

- Leadless type
- High precision characteristic covering up to high frequency range
- Designed for automatic mounting and reflow soldering
- Embossed taping specification
- The best choice of Bluetooth wireless communication sets, DSN, PDA and mobile phone

2. ELECTRICAL SPECIFICATIONS/产品技术指标

Output Frequency Range/ 中心频率	27.120000MHz
Mode/振动模式	AT/Fundamental
Frequency Tolerance/ 频率稳定度	±10 ppm max (at 25°C)
Load Capacitance(C _L)/ 负载电容	20.0 PF
Frequency Stability Over Operating Temperature Characteristics 温度频率稳定度	±30ppm max
Operating Temperature Range/ 工作温度	-40 °C to +85 °C
Storage Temperature Range/ 储存温度	-40 °C to +125 °C
Shunt Capacitance (C ₀)/静电容	3.0 PF Max
Driver Level (Typical) /激励功率	100μW
Equivalent Series Resistance(ESR)/ 等效电阻	50 Ω Max
Aging @25°C 1 st year (Max) / 年老化	±3ppm/year

QUARTZ CRYSTAL UNIT



SERIES 71, SEAM SEALED CERAMIC 5.0*3.2MM SURFACE MOUNT PACKAGE

3. DIMENSION / 产品规格尺寸 (Units: mm)

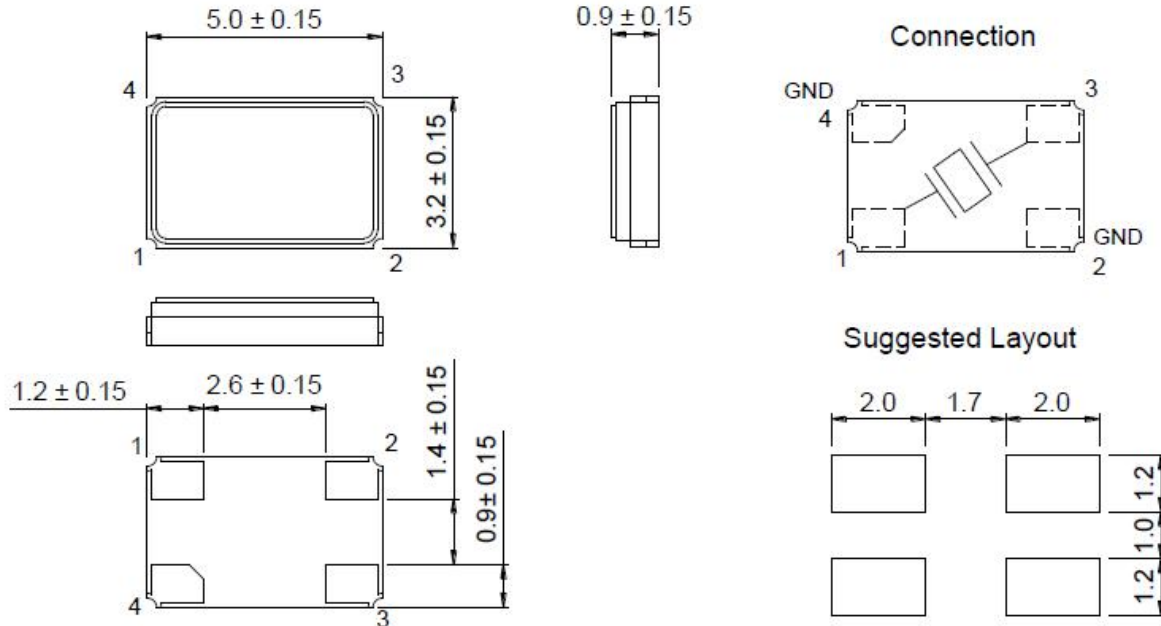

4. MARKING / 丝印

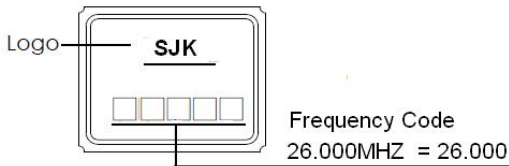

5. REFLOW CONDITION / 回流焊

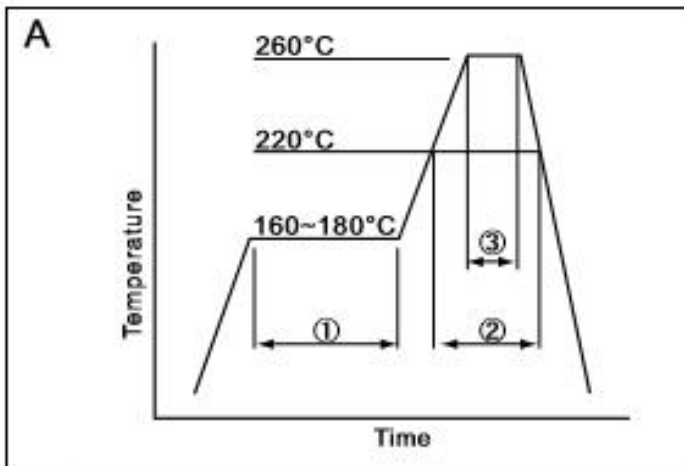

①	Preheat	$160 \sim 180^\circ\text{C}$	120sec.
②	Primary heat	220°C	60sec.
③	Peak	260°C	10sec. max

电话: 0755-88352810-837(Mr.huang) 传真: 0755-88353718 <http://www.q-crystal.com>
 公司地址: 深圳市龙岗区天安云谷产业园一期3栋C座12楼1204~1206室

QUARTZ CRYSTAL UNIT



SERIES 71, SEAM SEALED CERAMIC 5.0*3.2MM SURFACE MOUNT PACKAGE

6. STRUCTURE ILLUSTRATION/ 产品内部结构

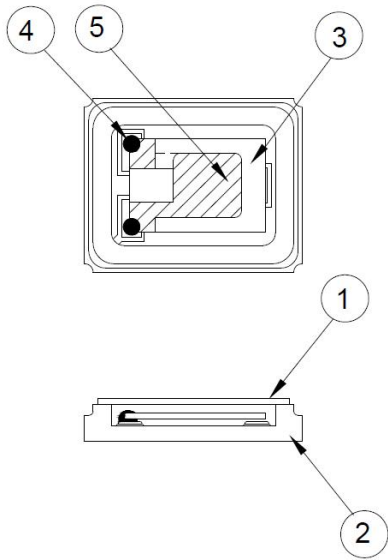

NO	COMPONENTS	MATERIALS	FINISH/SPECIFICATIONS
1	Lid	Kovar (Fe/Co/Ni)	-
2	Base(Package)	Ceramic (Al ₂ O ₃) + Kovar (Fe/Co/Ni)+Pad(Au)	Alumina ceramics
3	Crystal blank	SiO ₂	-
4	Conductive adhesive	Ag	Silicone resin
5	Electrode	Noble Metal	-

7. EQUIVALENT CIRCUIT AND OSCILLATION CIRCUIT

等效电路

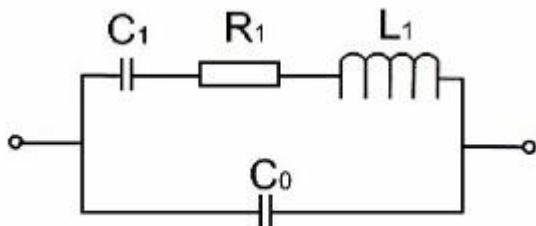

应用电路

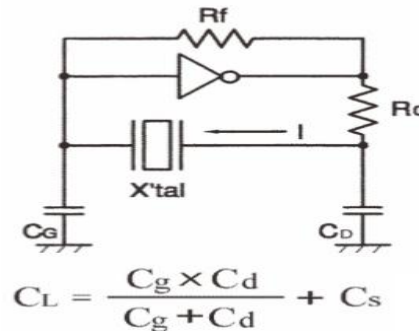

电话: 0755-88352810-837(Mr.huang) 传真: 0755-88353718 <http://www.q-crystal.com>
 公司地址: 深圳市龙岗区天安云谷产业园一期3栋C座12楼1204~1206室

QUARTZ CRYSTAL UNIT



SERIES 71, SEAM SEALED CERAMIC 5.0*3.2MM SURFACE MOUNT PACKAGE

8. RELIABILITY TEST SPECIFICATION / 可靠性试验

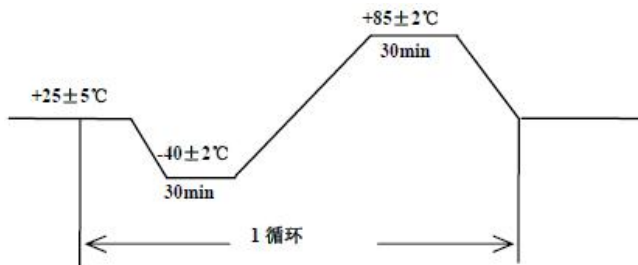
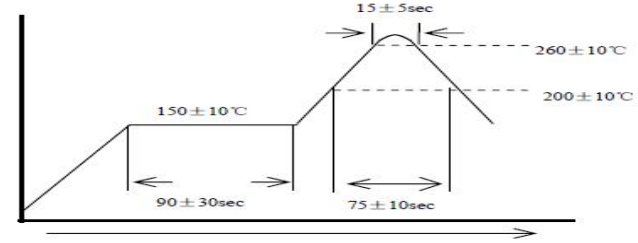
序号	试验项目	试验条件	标准要求
1	跌落	从 55cm 位置高度,自由跌落在木板上,连续 3 次	试验前后,频率变化不超过±5ppm, 电阻变化不超过±15%
2	振动	振动频率: 10~55Hz 全振幅: 1.5mm 时间: 每个方位三面(X、Y、Z) 各振动 2 小时	试验前后,频率变化不超过±5ppm,电阻变化不超过±15%
3	冷热冲击	晶体放入试验箱中, 高低温循环25次 低温为-40 ± 3°C保持30分钟,高温85 ± 2°C保持保持30分钟, 高、低温每3分钟变换一次 	试验前后,频率变化不超过 ± 5ppm,电阻变化不超过±15%
4	气密性	氦气气压标准: 5 ± 0.5Kg/cm ² , 氦气加压时间: 120 分钟	漏率标准: ≤ 1 × 10 ⁻⁹ Pa.m ³ /s
5	耐焊接热	波峰温度: 260°C ± 10°C 时间: 15 ± 5 秒 	试验前后,频率变化不超过±5ppm,电阻变化不超过±15%
6	沾锡试验	温度: 260°C ± 10°C 浸泡时间: 3 ± 1 秒	引脚沾锡后覆盖面积达90%以上
7	高温高湿	温度: 60°C ± 2°C 湿度: 90%~95% 保持时间: 240 个小时	1. 试验前后,频率变化不超过±5ppm,电阻变化不超过±15%

QUARTZ CRYSTAL UNIT



SERIES 7I, SEAM SEALED CERAMIC5.0*3.2MM SURFACE MOUNT PACKAGE

			2. 制品表面不可生锈
8	高温试验	高温温度：85°C±2°C 时间：240 个小时	试验前后,频率变化不超过±5ppm,电阻变化不超过±15%
9	低温试验	高温温度：-40°C±2°C 时间：240 个小时	试验前后,频率变化不超过±5ppm,电阻变化不超过±15%
10	寿命测试	電壓 5V 温度：25°C 时间：1000 小时	试验前后,频率变化不超过±5ppm,电阻15%

备注:

XTAL'MHZ 系列料号说明

SJK-	7U	12000/or12000A	-	E	20/or 20A	U	C	G
	封装	中心频率(MHZ)		频率精度	负载电容 (PF)	等效阻抗 (Ω)	工作温度	温度稳定度
例	7U:3225	12000:		A: ±5PPM	20.0:20PF	U:常规值	A:-10~60	A: ±5PPM
	7E:2520	12.000MHZ		B: ±15PPM	20A: 20.*(A代表	S:指定值	B:-20~70	B: ±15PPM
	7F:2016	12000A:		C: ±25PPM	小数点后的数		C:-40~85	C: ±25PPM
	7Y:1612	12.000***MHZ		D: ±50PPM	字)		D:-20~105	D: ±50PPM
	7I:5032/4PIN	(A代表小数量最		E: ±10PPM			E:-20~85	E: ±10PPM
	6I:5032/2PIN	后4~6位数值)		F: ±20PPM			F:-30~85	F: ±20PPM
	6G:6035/4PIN			G: ±30PPM			G:-40~105	G: ±30PPM
	7V:3225 GLASS			H: ±100PPM			H:-40~125	H: ±100PPM
	6A:49U			S: Spec			S: Spec	S: Spec
	6B:49S							
6BS:49SS								
6CS:49SMD								
6CSS:49SSMD								
6CA:M49SMD								

电话：0755-88352810-837(Mr.huang) 传真：0755-88353718 <http://www.q-crystal.com>
公司地址：深圳市龙岗区天安云谷产业园一期3栋C座12楼1204~1206室

单击下面可查看定价，库存，交付和生命周期等信息

[>>SJK\(晶科鑫\)](#)